

SFC-360

High Performance Microwave Coax Cable

Product Description

Surperlink SFC series coaxial cable is a standard semi flexible cable. It can be able to operate up to 40 GHz. SFC is ideal for microwave applications and has the ability to be stripped and formed into position without the need for any specialist tools. Traditional cut-and-strip machines can be used for the processing of the cable.

Feature & Benefit

- Standard Coaxial Cable
- It can be replaced for Sucoform-141
- Low Loss

Product Structure

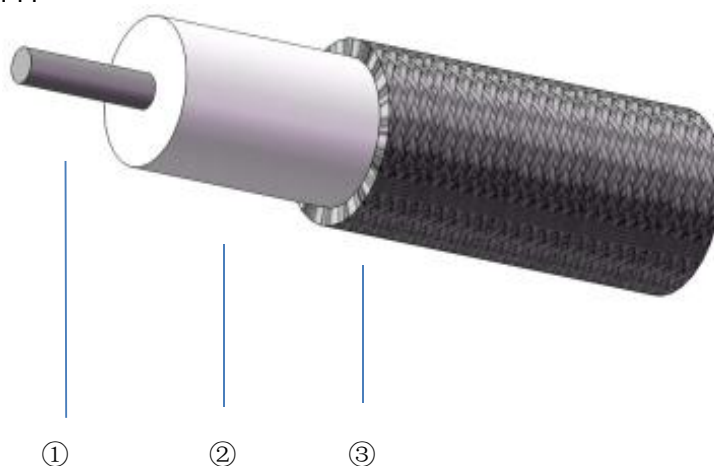

	①Center Conductor	②Dielectric	③Outer Conductor
Material	SPC	Solid PTFE	Tin Plated Copper
Size (mm)	0.94±0.03	2.92±0.05	3.60±0.15

Specifications

Impedance	50Ω
Operation Frequency	33GHz
Velocity of Propagation	70%
Shielding Effectiveness	90dB
Voltage Withstand	3000V,DC
Capactiance	98pF/m
Weight	38g/m
Temp, Operating&Installation	-65~165℃
Temp,Storage	-65~165℃
Bend Radius:installation	8mm
Bend Radius:repeated	40mm

The rights of technical information provided on the sheet belongs to Superlink. Contents cannot be provided to other third-companies without permission.

Shenzhen Superlink Technology Co.,Ltd
 Website: www.slkcorp.com
 Tel: +86 755-89814648

Attenuation (Typical@25°C VSWR=1.0)

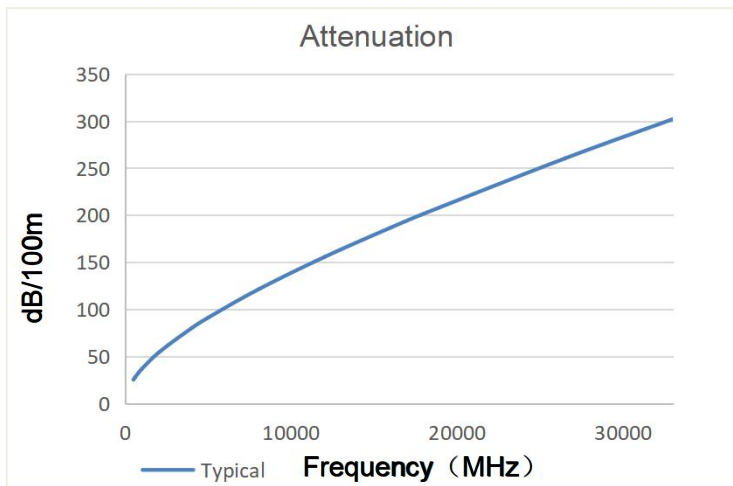

Frequency(MHz)	Attenuation (dB/100m)
500	25.1
600	27.7
800	32.4
1000	36.6
2000	53.7
4000	79.9
5000	91.1
8000	120.9
12000	155.5
16000	186.8
18000	201.6
26500	260.4
33000	302.1

$$K1= 1.049100$$

$$K2= 0.003380$$

$$\text{Attenuation}=K1* \sqrt{F}+K2*F$$

Power (40°C VSWR=1.0 Sea Level)

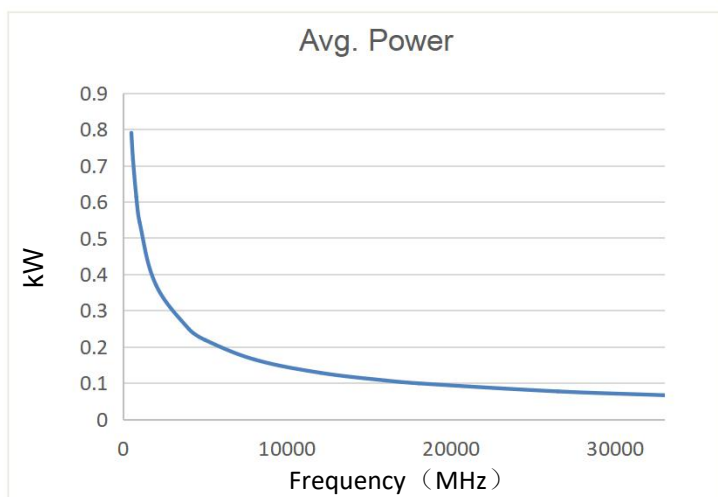

Frequency(MHz)	Avg.Power (kW)
500	0.790
600	0.717
800	0.614
1000	0.543
2000	0.370
4000	0.249
5000	0.218
8000	0.164
12000	0.128
16000	0.106
18000	0.099
26500	0.076
33000	0.066

Ver A-1